



SHORT SKIP



Sonoma County Radio Amateurs, Inc.

DECEMBER 1994

Club Station
W6LFFJ

P.O. Box 116
Santa Rosa, CA 95402

Repeater Station
WB6PVS

VOL 19 #12

Some of the US amateur packet nodes connected to the Internet:

AMPRNet/Internet Gateways

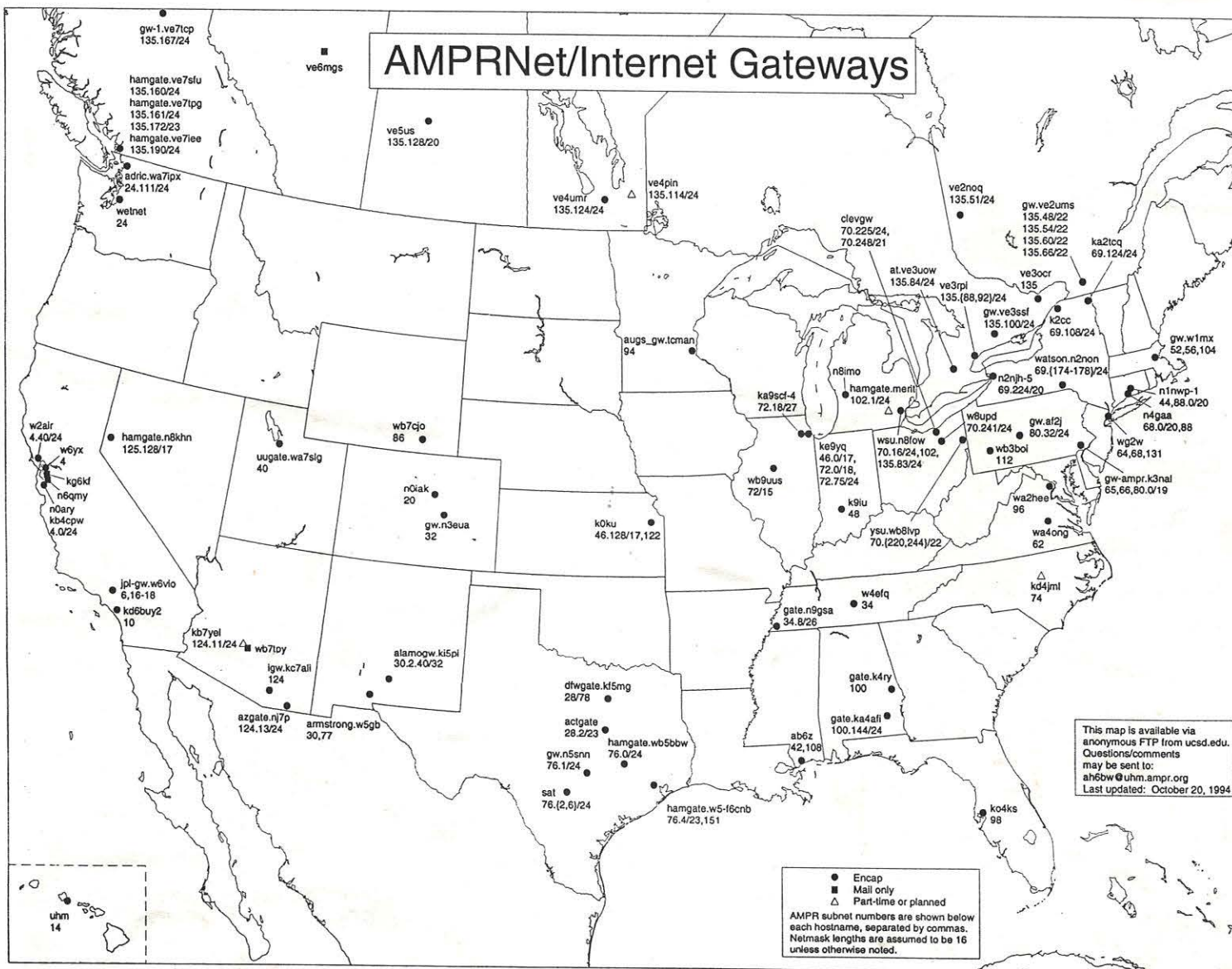



OFFICERS FOR 1994

PRESIDENT:	Merlyn Pfeiff	N6VUC	584-3898
VICE PRESIDENT:	Kelly Cureton	KD6CJQ	837-9434
SECRETARY:	Alan Bloom	N1AL	538-7115
TREASURER:	Mike Michlig	KN6JQ	526-9655
MEMBERS-AT-LARGE:	Kathy Mahan	KC6UXJ	823-4980
	Marie Mappus	KI6QY	664-1978
REPEATER CHAIRMAN:	Jim Rutherford	WB6PER	526-2972
ACTIVITIES CHAIR:	Mike Knope	KD6LYU	762-3236

SHORT SKIP STAFF:

EDITOR:	Alan Bloom	N1AL	538-7115
	1578 Los Alamos Rd, Santa Rosa 95409 alanb@sr.hp.com		
	AX.25 packet address: n1al@wx3k.#nocal.ca.usa.noam		
SWAP SHOP EDITOR:	Greg Cowles	KE6FXK	829-1583

QRV Editor: Jim Durkin KE6FSK
 AUDIO TAPING: John Breckenridge WB6FRZ, Laurel Meyer KC6FKX, Bob Phillips N6RMW
 CIRCULATION MGR: June Linnehan KD6LSU

Activities Committee:

- Pub. Service: Maris Mappus KI6QY 664-1978
- Pub. Relatns: Steve Carniglia KK6VY 579-9608
- QSL Mgr: Fred Leoni N6YEU 431-8202
- TVI/RFI: Al Bloom N1AL 538-7115
- Antennas: Joe Senft KM6TN 578-5824
 John KM6LI, Shep NH6ZY, N1AL
- Awards: Steve Lund WA8LLY 823-4544
- VEC Exams: Dave New AA6YX 829-6608
 N1AL WX3K WW6D WB6FRZ
 N6GHG AB6OL K6UXO AA6UY
 KC7VS KK6VY KK6XT WA8LLY
- Education: Steve Carniglia KK6VY 579-9608
 N1AL WB6FRZ KC6RHA KK6VY
 WB6TMY K6XZ K6ZWB KC7VS
- Refreshmnts at meetings: Bob Olsten WD6DPE
- Raffle at meetings: Dave Willey KD6KWM
- Membership lottery: Jim Andrews KC6PJW
- RACES RO: Jim Pelmulder N6PTM 823-7947
- ARRL Liaison: Alan Bloom N1AL 538-7115
- Badge Chair: Fred Leoni N6YEU 431-8202
- Packet BBS: John WX3K and Jim KC6PJW

Repeater Control Op's:

- WB6PER Jim 526-2972 N6PTM Jim 823-7947
- WD6CKP Hoppy 542-6750 N6VUC Merl 584-3898
- KD6CJQ Kelly 837-9434

Club Meetings:

7:30 PM, 1st Wednesday each month except December at the Hewlett Packard plant in Santa Rosa. (See map below.) All welcome.

Christmas party: December 7, 1994
PLACE: Cattlemen's Restaurant
TIMES: Social hour 6 PM, dinner 7-7:30

ARE YOU NOT AN SCRA MEMBER?

If so, then this is a complimentary copy. Our club is involved with almost every area of Amateur Radio: Repeaters (13/73), Field Day, license classes (Novice through Extra), volunteer exams, RACES, DX programs, packet radio, hidden xmtr hunts -- you name it.

We invite you to attend our next monthly meeting (see below) or check into the Tuesday night SCARS net on the 146.13/73 repeater at 7PM. You will hear the latest Amateur Radio Newsline broadcasts, announcements of SCRA activities and a Swap Shop. Membership in SCRA is open to anyone interested in Amateur Radio. If you would like to join, there is a membership application on page 11. Hope we can have an "eyeball" QSO with you at the next meeting! 73 ...

SHORT SKIP ADVERTISING RATES:

Business cards: \$10

\$11 First 1/4 Column
 \$3 Additional 1/4 Columns
 (\$32 Full Page, 1 side)

Pre-printed inserts: \$32/sheet

Guaranteed circulation: 200/month
 AD DEADLINE: 10th of previous month

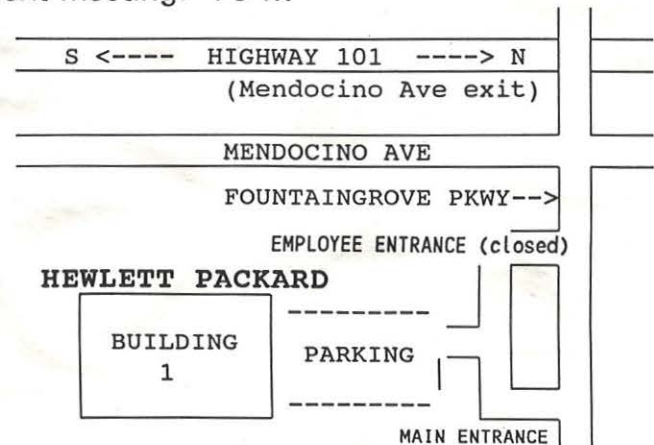

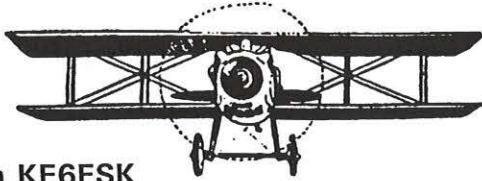
QRV

by
James Durkin KE6FSK

Irritation! Everybody has experienced it from time to time. And with it comes the intense desire for retaliation. We all seek revenge. However, *hams* are notoriously famous for being polite. Hams don't do anything immoral, illegal or fattening. At least, not on the air.

When an intentional jammer plies his trade, we simply ignore him in the knowledge that he will soon tire and go away. It may take anywhere from an hour to a week, but eventually he is gone and we are no more the worse for wear. Except that the knowledge that we did the "right thing" gives no vent to our deeper frustration.

Nevertheless, we go on, upholding a tradition that is longstanding and proven. And we do so willingly, until we are presented with another source of irritation that we cannot ignore. I am speaking, of course, of what I call the "legal" jammer.

We all know him/her. Every repeater has one. This is the person who has passed his license exam, received his call sign, and proceeded to tie up the frequencies with nonsensical QSOs and repetitive useless information. We try to be helpful and inform this person of proper radio procedures. Sometimes the person will agree with you. More often than not, the person will become hostile. After all, he *did* earn his ticket same as you. He has the same right to use the radio as you. Now *you* have become the sole source of irritation. *you're* the one who's wrong. Now *he* wants revenge. What do you do?

You can topple his antenna (not a recommended procedure). You can put a pit bull in his garage (not recommended, either). Or you can verbally bash him among your fellow hams (a practice I am guilty of, I must admit). Unfortunately, none of these solutions offer much in the way of practicality.

I originally became a licensed ham to broaden my world. In many respects ham radio has more than fulfilled this. Then, I encounter L.J. (legal jammer) who made me wonder whether it was worth the effort. L.J. constantly broke

in on conversations, ignoring whether his two cents was welcome or not. He would often answer a call for help knowing there was absolutely no way he could be of any assistance. He was, in fact, a major source of *irritation!* Then, something unique happened.

I met L.J.! Whereas I had become a ham to broaden my world, Amateur Radio *was* his world. L.J., you see, is one of those special individuals who came into the world with less tools than the rest of us. I could yell at him until my face turned blue, or I could grin and bear it. It would make no difference to L.J. either way. Life hadn't been fair to him. And, being a ham, I wasn't about to make it worse.

So what do we do when we encounter the L.J.'s of the world? I can't say for the rest of you, but for me, I would prefer a hundred L.J.'s over a single illegal jammer any day! ■

Christmas Party!

In lieu of the December meeting, we'll hold our annual Christmas party Dec 7 at Cattlemen's restaurant, located at 2400 Midway Drive, (Montgomery Village) Santa Rosa. No-host cocktails start at 6 PM, with dinner served between 7 and 7:30. The program will start around 8:30, and we should be out of there by 9:30.



There's a choice of a 9½ ounce sirloin, teriyaki chicken or salmon for \$14.95, gratuity included. Please RSVP to N6VUC or on the Tuesday net, so we know approximately how many are coming. ■

Jim Pe mulder
N6PTM

(707) 823-7947

NOB HILL ELECTRONICS REPAIR

Amateur - Commercial - Scanners
TV - VCR's - Audio

Sta. Lic. No.
26191

2801 Gravenstein Hwy. No.
Sebastopol, CA 95472



SCRAPS: SCRA Public Service

By Marie Mappus KI6QY

1994 in Retrospect

All of the 1994 public service events are now behind us. We had a busy Spring, Summer and Fall in which we participated in sixteen different walks, runs, bike tours, triathlons, and river events. We contributed 1,444 hours of volunteer work for such fund raisers as the March of Dimes, Easter Seals, Multiple Sclerosis, Special Olympics,, Human Race, Society for Independent Living, etc..

I would like to say a special thanks to all the amateurs who participated in these events: Mark KO6AP, Colleen KE6ARL Betty AG6C, Gary KD6BOF, Kelly KD6CJO, Hoppy WD6CKP, Chuck N6DDK, Bob WD6DPE, Richard KE6DRV, Hank W6DTV, Lee KE6EAQ, Greg KC6EAD, Jim WA2EWE, Sarah N6FAX, Jim KE6FSK, Greg KE6FXK, Jim KD6GCD, Bob K6GEV, Bill N6GHG, James KD6GSF, Ken N6GXI, Georgia N6GZU, Andrew KE6HID, Brian N6IY, Jack KN6IO, Clarence W6IZR, Peter N6JBV, Bill KA6JLP, Rudy N6KLU, Matthew KD6KVK, Dave KD6KWM, Dave KD6LSA, June KD6LSU, Bill KD6LTA, Mike KD6LYU, Ken N6MHG, Wilbur N6MGY, Michael KC6NDS, Steve KC6NEO, Bill WA6OLW, Phil N6OOA, Ronald KD6OTC, Adam KC6POC, Ted KB6PTA, Jim N6PTM, Doug KC6RHA, Bob N6RMW, Tim KD6TXK, Pat KD6TYJ, Clark KD6UHH, Kathy KC6UXJ, Rick KC6UXI, Pete KC6UXM, Ross KD6VBV, Larry KC6VJI, Merl N6VUC, George KD6WIR, Nadine KC6WUI, Steve N6WMW, Harold KD6WYF, Tony KD6WYH, Fred N6YEU, Mark KM6XV, Dave AA6YX, and Rick K6ZWB without whose enthusiastic participation the events could not have functioned as flawlessly and effortlessly as they did.

The sponsors of the public service events are already busily preparing for the upcoming 1995 season. Shortly after the first of the year we too will begin working on our calendar of events. Many of the same events will be repeated again and perhaps, as with this year, there will be additional events added to our regular program. Hopefully all of you will participate again next year. We also encourage new Hams to get involved. It is an interesting and rewarding experience.

Again many many thanks for all of your help. We look forward to another busy year in '95.



In re: Sunday, Oct. 16, 1994

At approximately 1630 hrs., Anthony (KE6EIO) was near the top of Mt. St. Helena when he was approached by a distressed person who declared that his son had been in an accident resulting in the loss of the boy's finger. Anthony put out an emergency call on the 146.730 repeater.

Adam (KD6POC) responded to the call and despite Anthony's low batteries on his hand-held, was able to determine the location of the boy and the extent of his injuries and relayed the same to the appropriate authorities. All this was done with the utmost professionalism despite all parties concerned being obviously under considerable pressure.

As a ham who became involved in the hobby primarily because of my interest in the community, I was highly impressed with their performance and would recommend a special award for these two highly dedicated radio amateurs.

Yours truly, James B. Durkin KE6FSK

1994 Field Day Results — San Francisco Section

John Wallack W6TLK, SF Section Manager

Class	Call	Club/group	Total Points
1A	WN6W	Non-club group	3308
1A	KE6WC	So. Humboldt ARC	728
2A	N6OJ	Redwood Empire DX	4854
2A	KI6OI	Bedega Bunny Club	3496
2A	K6WC	Willits ARS	2592
2A	W6YX	Stanford ARC	2082
2A	W6MN	Anchor Bay ARC	1932
2A	K6AYD	Lake County ARS	1910
2A	AB6TR	Humboldt ARC	1220
3A	AB6XR	Sonoma Mt. Rptr. Soc.	2562
3A	W6PW	San Francisco ARC	2410
3A	WB6DWY	Valley of the Moon ARC	1744
4A	W6LFJ*	Sonoma County RA	5174
4A	W6SG	Marin ARC	2778
1B	N1AL	Al Bloom	2148
1B	KB6GV	Vincent Henley	658
1E	W6JTI**	Frank Letton	6720

* W6LFJ, highest CLUB score

** W6JTI, highest TOTAL score

Send Short Skip Articles by Packet!

It's easy to send in newsletter articles by packet. It's easy for you, since there is nothing to print and mail. And it's easy for me since I don't have to re-type the article!

Here's how: First type the article on your computer using your favorite word processor. Store the article as an "ASCII file" on disc.

Now log onto a Packet Bulletin Board System (PBBS). Either KC6PJW (RPBB) or WX3K (ROCK*) are convenient from Sonoma County. If you can't hit them directly, try connecting via the SONOMA node on Sonoma Mountain.

- or: C WX3K [145.09 MHz]
- or: C KC6PJW [145.73 MHz]
- or: C SONOMA [145.73 MHz]
- or: C WX3K [while connected to SONOMA]

When you see the BBS's prompt, Send a Personal message to me:

SP N1AL@WX3K

The BBS will ask you first for a message title, and then for the text. At this point, do an "upload", or whatever it is called in your terminal program, to send the ASCII file to the TNC. When done, type the character control-Z (^Z) or "/EX" to terminate the message.

That's it! I'll acknowledge receipt by packet (or other method if you prefer), and you'll see your name appear in glorious print in the next issue of Short Skip!

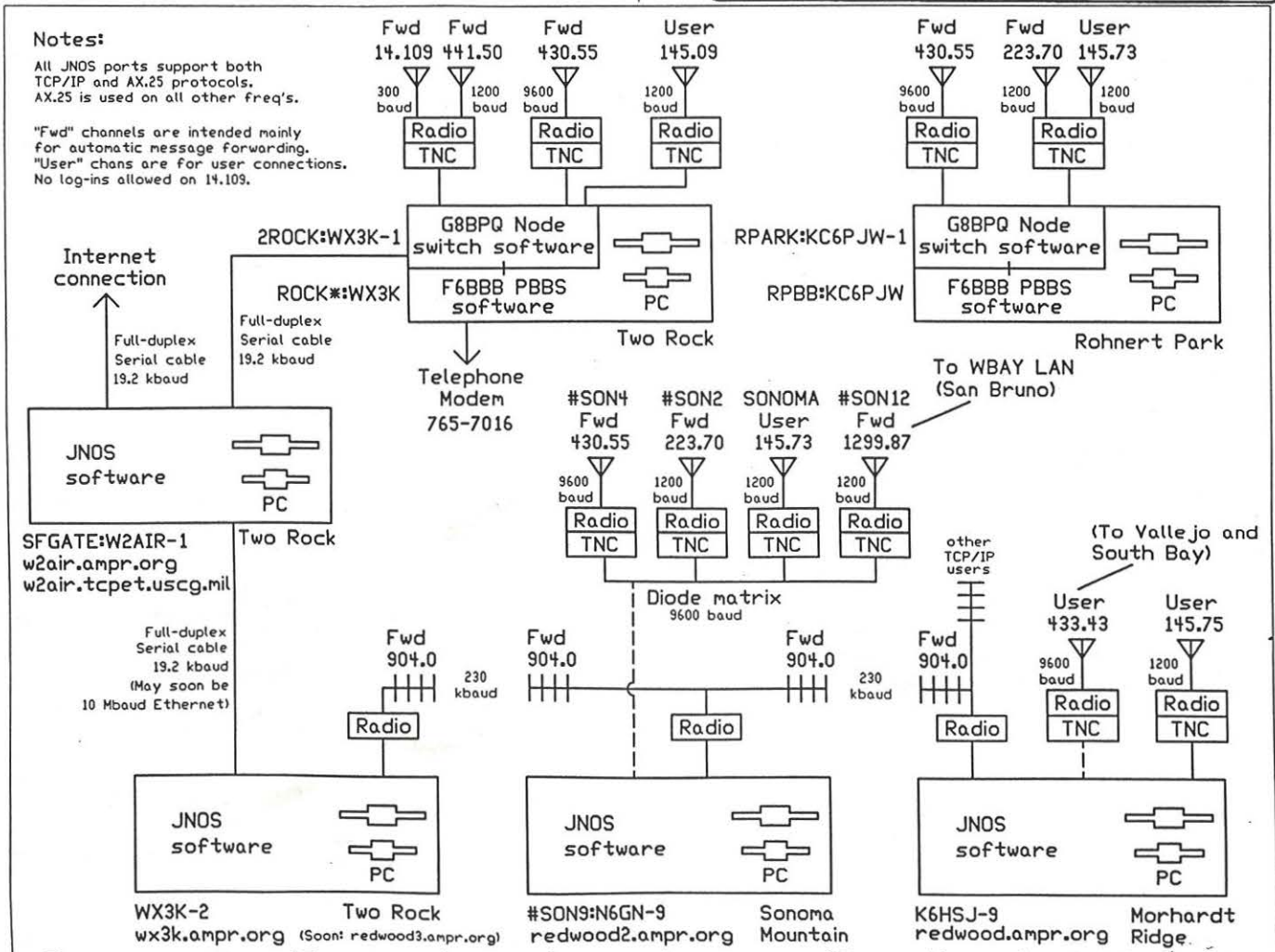
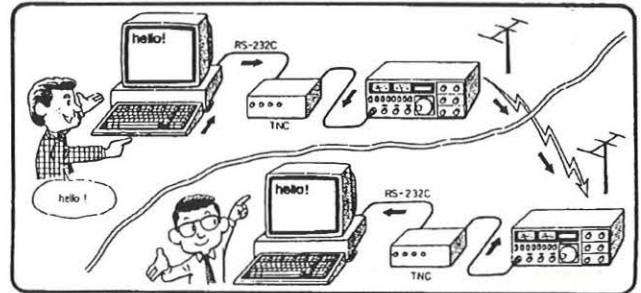

Sonoma County Amateur Radio LANs

N1AL-11/15/94

SFGATE established!

by John Zantek
WX3K



Some long-planned initiatives to the network in the NCOAST LAN have finally made it to the deployment stage and we felt it was time to put out the word on these strategic improvements.

1. SFGATE:W2AIR-1 has been established. This is a JNOS computer at the USCG site of WX3K BBS. The JNOS box and the WX3K AX.25 BBS with it's G8BPQ node switch (2ROCK:WX3K-1) are tied serially together via wire. SFGATE has three hardware ports:

a. to 2ROCK:WX3K-1 (the G8BPQ switch) and ROCK*:WX3K BBS.

b. to wx3k.ampr.org [44.4.40.104], another JNOS TCP/IP box.

c. to the Internet. SFGATE:W2AIR-1 is also fully TCP/IP capable as w2air.ampr.org [44.4.40.138] and reachable from the Internet, and can reach out TO the Internet. We have encapsulated several AX.25 links to other gateways, including (as a sample):

OLUOLU (Hawaii)
MBGATE (Manitoba)
RYEHAM (Ontario)
UUGATE (Utah)
RENONV (Nevada)
ANCHOR (Alaska)
MEMIP (Tennessee)

These and other encapsulated Net/Rom routes to sites all over the planet will appear.

2. #SON9:N6GN-9 has been established. This is a JNOS computer atop Sonoma Mountain. #SON9 has two hardware ports:

a. to the existing Net/Rom nodestack (SONOMA, #SON2, #SON4) via a diode matrix, which allows both the TCP/IP network and the conventional AX.25 NCXPN network to gateway into each other.

b. to a 'fast' radio port. #SON9 (redwood2.ampr.org) is additionally tied to SFGATE and other TCP/IP sites in Northern

California via a 230kilobaud RF linking system (yes, I said 230 KILOBAUD). The higher speed hardware involved in the system uses the 10W, 904MHz digital radios designed and built by N6GN and previously reported in the Autumn 1993 edition of NCPA's "Downlink". The TNC-2 controllers which had previously limited speeds to 38.4kbps have been replaced with Ottawa Amateur Radio Club PI2 cards hosted by the 386 JNOS computers at our sites. N6GN has modified these cards and their drivers so that they can support the higher speed. Antennas at these 'fast port' sites are 5 foot yagis but the hilltop sites use two of them fed with a power splitter to allow tailoring of the coverage area to fit our architectural needs. Performance of the system is good. File transfers on large files is up to 75% of the channel capacity or better than 18,000 bytes/sec over a single hop and around 34,000 bytes/sec over the longest radio path, which is currently 3 hops for a total path length of about 75 miles.

We hope to soon add (this week):

a. A 1.2GHz link between the Sonoma Mountain nodestack and the San Bruno nodestack of WBAY LAN. The southern terminus is almost complete and all equipment is on hand for the northern end.

b. A 430MHz link between our most northern 'fast ported' site at redwood.ampr.org, another mountaintop JNOS box, and one or more southern IP stations, at Vallejo and/or South Bay.

What does this offer to network enhancement? In the case of the 230 kbps links, a digital pipe that can handle amazing bandwidth. What does this offer the generic packet user? Lots!

a. The NCPA IP networks and AX.25 BBS networks are now a single, interoperable network.

b. Additional servers. From SFGATE, you can (among other things):

Access Net/Rom sites throughout the world.

Access the online callbooks of SAM, QRZ?, and others.

Access the DX spotting networks of other spots on the planet.

Access the International Converse Server.

Access and get the latest NOAA weather forecast for your selected area, where ever that may be.

Access all Northern California amateur TCP/IP hosts.

We're running the system as open as Part 97 allows. There ARE some restrictions we must deal with (third party international, et al), but we're attempting to provide as broad a customer service as possible.

Take SFGATE for a test drive. Remember, throughput to/from your station will probably only be limited by the speed of your 1200 baud TNC link. Everything else is running at much higher speeds. We also offer dial-in capability to and gatewaying capability from the WX3K BBS, but that's left for coordination on a user-by-user basis.

For further details, feel free to contact any of the following addresses:

AX.25 BBS: wx3k@wx3k.#nocal.ca.usa.noam
kc6pjw@kc6pjw.#nocal.ca.usa.noam
n6gn@wx3k.#nocal.ca.usa.noam

Amprnet: wx3k@w2air.ampr.org
jim@w2air.ampr.org
glenn@santarosa.ampr.org

Internet: jzantek@tcpet.uscg.mil
jandrews@sr.hp.com
glenne@sr.hp.com

73 from the NCOAST LAN team ■

Glossary of Packet Terms in This Issue:

Amprnet A set of Internet addresses, for nodes that connect to the amateur packet radio (ampr) network.

AX.25 The traditional protocol used on amateur packet radio.

G8BPO node switch A PC program that mimics Net/Rom routing between the ports connected to the computer.

Gateway A connection between two dissimilar networks, such as the Internet and the amateur packet network.

IP Internet Protocol. Same as TCP/IP.

JNOS WG7"J" Network Operating System. An operating system based on the KA9Q system that allows TCP/IP connections.

LAN Local Area Network. Normally refers to a group of computers connected by wire or fiber optic cable, but now the term is often used for similar radio networks.

NCPA Northern California Packet Association.

NCXPN The sysops (system operators) of NCPA packet bulletin boards.

Net/Rom A program that replaces the normal software in a packet TNC. It allows easier connection to distant nodes (stations).

Nodestack A group of packet radio nodes connected together by wire.

PBBS Packet Bulletin Board System. Like a telephone BBS, except connected by radio.

SFGATE:W2AIR This format indicates an alias (SFGATE) and callsign.

TCP/IP Transport Control Protocol / Internet Protocol. The protocol used on the Internet "information highway" and now also used on some packet radio links.

USCG United States Coast Guard. The USCG has a training center at Two Rock.

wx3k.ampr.org [44.4.40.104] This format indicates an Internet (IP) address. The numerical address in brackets is used if the "English" one doesn't work.

wx3k@wx3k.#nocal.ca.usa.noam This format indicates an amateur packet address on the AX.25 network.

HSC **Halted**
specialties co.

Electronics • Prototyping Supplies • Computers • Lasers

George Shedore
Manager
KS6W

6819 REDWOOD DRIVE
COTATI, CA 94931

PHONE: (707) 792-2277
FAX: (707) 792-0146

RENEW YOUR ARRL MEMBERSHIP THROUGH THE CLUB AND WE GET TO KEEP \$2 (no expense to you). Write your check to SCRA, and send it with your ARRL renewal form to SCRA, POB 116, Santa Rosa, CA 95402 or give it to the Treasurer. ■

SCRA MINUTES

November 2, 1994

Submitted by Secretary
Al Bloom N1AL



The meeting was called to order by President Merl Pfeiff N6VUC at 7:40 PM. Other officers present were Vice President Kelly Cureton KD6CJQ, Secretary Al Bloom N1AL, Treasurer Mike Michlig KN6JQ, Repeater Chairman Jim Rutherford WB6PER, and Members-at-Large Marie Mappus KI6QY and Kathy Mahan KC6UXJ.

VISITORS: We had 1 visitor. **UPGRADES:** AC6FR has upgraded to Extra and KH6GJV is now an Advanced.

The **MINUTES** for last month should have said the elections are in November, not December. They were approved as amended m/s KB6PTA/? The **TREASURER'S REPORT** was approved as read. m/s WD6DPE/K6ZWB

REPEATER: WB6PER noted that there is no way to adjust the volume of the time announcer's voice. You can avoid it if you realize it comes on right after the squelch tail.

The **AUTOPATCH CODES** have been changed since the membership packet was printed. Make sure you have the update sheet, as printed in July *Short Skip*. They are supposed to be passed out with the packets.

PUBLIC SERVICE: Marie KI6QY noted that club members put in 1444 hours on SCRAPs activities this year.

EDUCATION: Education Chairman Steve KK6VY reports that Jim WA2EWE is in his 5th week of the Technician class. It is meeting now in the EOC.

PUBLIC RELATIONS information can be reported via the SCRA Information Hotline to PR Chairman Steve KK6VY. The Hotline is getting 35-40 calls per month.

VE EXAMS Dave AA6YX and the other tri-county VE teams met recently to coordinate exam sessions next year. SCRA sessions will generally fall on the second weekend of the month. Claude AB6OL will be the Chairman next year.

An **SCRA MEMBERSHIP DIRECTORY** is being worked on by Rick K6ZWB and Kathy KC6UXJ. Look for a form in the January *Short Skip* for everybody to fill out.

The **PACKET BBS** will be transferring to Jim KC6PJW when John WX3K (now a Lt. Commander) is transferred. You can now access both WX3K and KC6PJW via the Internet.

NET CONTROL STATION for January is Jim KE6FSK.

The 1994 **FIELD DAY** competition between SCRA and REDX was won by . . . **SCRA!** N6YUE, who holds dual citizenship, acknowledged SCRA's victory on behalf of REDX.

ELECTIONS: Nominating Committee Chairman Rick K6ZWB presented the nominees for 1995 officers: President Kelly Cureton KD6CJQ, Vice President Dave New AA6YX, Secretary Al Bloom N1AL, Treasurer Joel Nadler KJ6LF, and Members-at-large Steve Feil KD6CJR and Marie Mappus KI6QY. Angela Dickey KC6OCD was nominated from the floor for Treasurer (m/s WB6PER/KD6KWM). She was also nominated for Member at Large (m/s WB6PER/KE6FSK) along with Greg Cowles KE6FXK (AA6YX/KD6VUM) Jim Andrews KC6PJW (WX3K/KOMQT), and Joel Nadler KJ6LF (KK6VY/K6ZWB). The following table lists the winners and the persons moving and seconding that nominations be closed:

Office:
President
Vice President
Secretary
Treasurer
Members at Large

Winner:
KD6CJQ
AA6YX
N1AL
KC6OCD
KI6QY
KC6PJW

Moved/seconded:
WB6PER/KB6UCM
N6PTM/KK6VY
N6DDK/KK6VY
KE6FSK/KB6UCM
KB6UCM/W6TLK

For the **MEMBERSHIP LOTTERY** this month, we drew continuously until the winner was present. Bill WD6DXW was the lucky winner of \$52.55.

In view of the upcoming elections, it was pointed out that Mr. Dave Berto was the only Santa Rosa City Council member who voted against us in the recent antenna vote.

The meeting adjourned at 9:36 PM. m/s N6DDK/N6KLU
Respectfully submitted by Al Bloom N1AL. ■

Board Meeting Minutes

November 9, 1994

The meeting was called to order by President Merle Pfeiff N6VUC at 5:32 PM in the meeting room at the Northbay Savings Bank. Other officers present were Vice President Kelley Cureton KD6CJQ, Secretary Al Bloom N1AL, Repeater Chairman Jim Rutherford WB6PER, Member-at-Large Marie Mappus KI6QY, and President Emeritus Rick Reiner K6ZWB. Also present were 1995 Treasurer Angela Dickey KC6OCD and four other SCRA members.

The **CHRISTMAS PARTY** dinner will be \$14.95 for steak, chicken or salmon. Service awards recipients were discussed.

TOYS FOR TOTS: Jim WB6PER moved we again donate \$200 to this worthy organization for Christmas. (second K6ZWB) Unanimously approved.

Jim also spoke to the need to get more member-written articles for *Short Skip*. Bob WA6MXI and Al K6QXY could give a talk on moonbounce at some upcoming meeting. The new repeater firmware is not yet installed.

The **TREASURER'S AUDIT** as required in the constitution must be done soon. Jim N6PTM agreed to be auditor.

STORAGE LOCKER: N6PTM needs to know how big a locker to ask for. Before the next Board meeting, everyone get Jim a list of any club equipment they have or know about.

ANTENNA COMMITTEE: Joe Senft KM6TN reported on a meeting with Santa Rosa City Attorney Bruce Leavit. He received a good education about antennas, why they need to be a certain size, etc. Mr Leavit will prepare a proposed ordinance to present to the Planning Commission. Meeting adjourned. m/s WB6PER/K6ZWB
Respectfully submitted by Al Bloom N1AL. ■

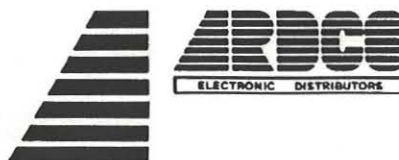

345 West College Ave, Santa Rosa, CA 95401 (707) 527-6000

STEVE BASHAM
Manager

HSC ELECTRONIC SUPPLY

GOODIES FOR THE RADIO AMATEUR:

RAMSEY KITS:

- 50/144/220/440 MHz Synthesized Transceivers
- VHF power amplifiers
- All-mode HF receivers
- QRP CW Transmitters
- Etc...



- MFJ accessories
- Code keys
- Wire Antennas
- Surplus Electronics
- Tools, parts, Etc...

ARRL BOOKS:

- ARRL Handbook
- License Manuals
- Antenna Books
- Etc...

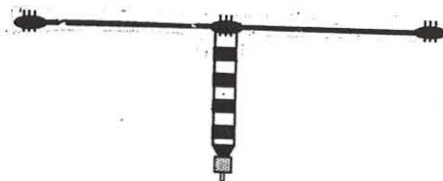
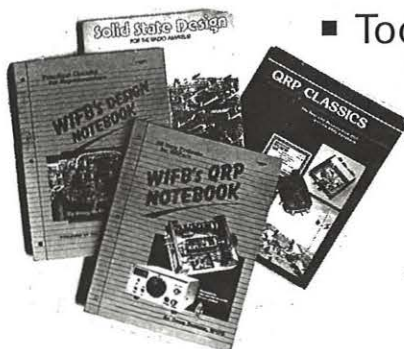

YOUR IBM CLONE HEADQUARTERS

FROM PC-AT's TO STATE-OF-THE-ART 80486 SYSTEMS,
YOU'LL FIND IT AT HSC



- Complete systems
- Cases, Supplies, Motherboards
- Hard/Floppy Discs, Monitors
- I/O Cards, Memory Chips
- Software, Etc...

HSC

Halted
specialties co.

Electronics • Prototyping Supplies • Computers • Lasers

George Shedore
Manager
KS6W

6819 REDWOOD DRIVE
COTATI, CA 94931

PHONE: (707) 792-2277
FAX: (707) 792-0146

> 12 STORE BUYING POWER! <

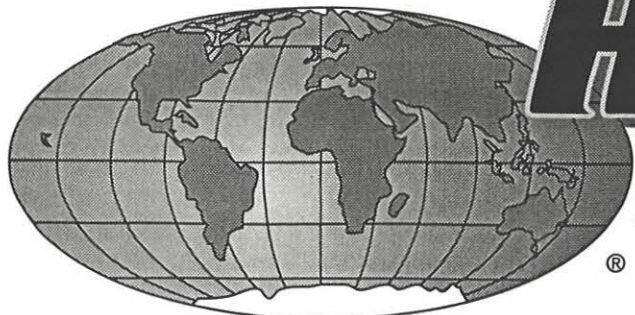

HAM RADIO OUTLET

WORLDWIDE DISTRIBUTION

SUNNYVALE, CA 94086
510 Lawrence Expwy. #102
(408) 736-9496
(800) 854-6046
Tom, KB6LUC, Mgr.
Lawrence Expwy.
So. from Hwy. 101

OAKLAND, CA 94606
2210 Livingston St.
(510) 534-5757
(800) 854-6046
Rich, WA9WYB, Mgr.
I-880 at 23rd Ave. ramp

Phone Hours:
9:30 AM to 5:30 PM
Store Walk-In Hours:
10:00 AM - 5:30 PM • Closed Sundays

Call/Write for your HRO Catalog!

ANAHEIM, CA 92801
933 N. Euclid St.
(714) 533-7373
(800) 854-6046
Janet, WA7WMB, Mgr.
Near Disneyland

PORTLAND, OR 97223
11705 S.W. Pacific Hwy.
(503) 598-0555
(800) 854-6046
Earl, KE70A, Mgr.
Tigard-99W exit
from Hwy. 5 & 217

OAKLAND, CA 94606
2210 Livingston St.
(510) 534-5757
(800) 854-6046
Rich, WA9WYB, Mgr.
I-880 at 23rd Ave. ramp

DENVER, CO 80231
8400 E. Iliff Ave., #9
(303) 745-7373
(800) 444-9476
Joe, KD0GA, Mgr.

SAN DIEGO, CA 92123
5375 Kearny Villa Rd.
(619) 560-4900
(800) 854-6046
Tom, KM6K, Mgr.
Hwy. 163 &
Claremont Mesa

PHOENIX, AZ 85015
1702 W. Camelback Rd.
(602) 242-3515
(800) 854-6046
Gary, WB7SLY, Mgr.
East of Highway 17

SUNNYVALE, CA 94086
510 Lawrence Expwy. #102
(408) 736-9496
(800) 854-6046
Tom, KB6LUC, Mgr.
Lawrence Expwy.
So. from Hwy. 101

ATLANTA, GA 30340
6071 Buford Highway
(404) 263-0700
(800) 444-7927
Mark, KJ4VO, Mgr.
Doraville, 1 mi.
no. of I-285

VAN NUYS, CA 91411
6265 Sepulveda Blvd.
(818) 988-2212
(800) 854-6046
Jon, KB6ZBI, Mgr.
San Diego Fwy.
at Victory Blvd.

WOODBIDGE, VA 22191
Washington D.C. area
14803 Build America Dr.
(703) 643-1063
(800) 444-4799
Curtis, WB4KZL, Mgr.
Exit 161, I-95, So. to US 1

NEW STORE!
NEW CASTLE, DE 19720
1509 N. Dupont Hwy.
(302) 322-7092
(800) 644-4476
Kent, KD1IJ, Mgr.
RT.13 1/4 mi., So. I-295

SALEM, NH 03079
Boston, MA area
224 N. Broadway
(603) 898-3750
(800) 444-0047
Chuck, KM4NZ, Mgr.
Exit 1, I-93;
28 mi. No. of Boston

AZ, CA, CO, GA, VA residents add sales tax.
Prices, specifications, descriptions, subject
to change without notice.

ALINCO

DJ - 580T



2M/440 Dual Band
40 Mem Channels
DSQ, Dual Display
CTCSS Enc./Dec. Built-In
Cross Band Full Duplex

**CALL FOR
SPECIAL
LOW PRICE**



HANDHELDS



FT-530
2M/440MHZ

2W Standard, 5W opt.
82 Mems, Dual In-band RX
DTMF paging + coded Sgl. std.
Built-in VOX & CTCSS
Auto tone search
Built-in clock • Backlit Keyboard
SPECIAL PRICING!

KENWOOD

TS - 50S/TS - 60S

HF Transceiver 6M



TS-50S - World's smallest HF Transceiver
100W out. (90W TS-60S, 50MHz only)
SSB, CW, AM, FM
12V Gen. Cov. RX, 6.4 lbs., 7.16 x 2.4 x 9.32"
105db dynamic range, 100 Mems.
Opt. ext. ant. tuners available (TS-50S only)

CALL NOW FOR OUR LOW PRICING!



HANDHELDS



IC-D1A
2M/440/1.2 Tri-Band

IC-W21AT/IC-V21AT
2M/440 2M/220

IC-2GXAT, 2M

IC-T21A, 2M **NEW!**

ALINCO

DR - 600T

2M/440 FM Transceiver



45W/35W + Airband RX
Detachable/Remotable Head
Keyboard freq. entry from microphone!

CALL FOR OUR SPECIAL PRICE!



FT - 990



100W HF Gen. Cov. Transceiver
DDS, QSK • 500Hz CW Filter Included

CALL FOR OUR LOW PRICE!

KENWOOD

HANDHELDS

TH-79A
2M/440HT

2.7W 2M, 2W 440
5W Optional
DTSS Built-In
82 Memories
DTMF Memories
Built-In CTCSS Enc./Dec.
User-Friendly Menu Sys.
**CALL NOW FOR
INTRO SPECIAL!**

TH-22AT

Ultra Compact
2M HT, 5W opt.
40 Memories
Encode Built-In
CALL NOW!



IC - 737A

HF Transceiver



12V 100W w/auto Ant. Tuner
Built-in Gen Cov. RX, 101 Mems., VOX
DDS, QSK, Passband Tuning

**Priced So Low, We Can't Print It!
Call For Your Low Discount Price!**

Twas the Net Before Christmas

By Kathy Mahan, KC6UXJ



Twas the net before Christmas
And all through the house
Not a radio was on
To the delight of my spouse.

The mic's and ht's were all hung with care
Not a single squelch from anywhere.
The Icoms and Kenwoods were all in a line
So I just layed back sipping my wine.

When out on the roof there arose such a clatter
I sprang from my seat to see what was the matter.
Away to the window I flew like a flash
Tore open the shutter and threw up the sash.

The moon shone so bright on the top of my quad
It gave a luster of midday to my neighbor's sod.

When what to my wondering eyes should appear
But a miniature sleigh filled with radio gear,
With a little old driver exactly on course
I knew in a moment t'was ole Samuel Morse.

More rapid than eagles his coursers they came
And he whistled and shouted and called them by name,

A Kenwood, an Icom, a Yaesu for starters
An Ameritron, Santec & Alinco for barter.

To the top of the porch to the top of the wall
I could only hope he wouldn't fall.
And then in a twinkle he was on the roof
And the dits and dahs were certainly proof.

As I drew in my head and was turning around,
Down the antenna ole Sam came with a bound.

He was dressed in cognito from his head to his foot,
And his clothes were all tarnished with ashes and soot.
A bundle of radios he had flung on his back
And he looked like a salesman just opening his pack.

The radios how they sparkled, all clean and new
I only hoped he would just leave a few.
Then he turned on an ht - 2 meters was free
He hoped to say a few words on 146.73.

He gave his call sign, WB6SAM
Hoping for a contact with any ham
Then he sprang up the antenna
Without a dilemma

And pressing his finger on the PTT
He gave a memorable QST.
And I heard him exclaim has he drove out of sight
Happy Christmas to all and to all a good night.

DEC
1994

Application for Membership in SCRA

Name _____ Callsign _____ Lic. Class _____

Addr. _____ Phone Nr _____ () New Mbr

_____ ZIP _____ Date _____ () Renewal

Dues: \$12/year, \$18/year family. New members also pay a \$6/person initiation fee. Dues for new members *only* are pro-rated \$1 (\$1.50 family) per month, starting at renewal time, March 1.

I WOULD LIKE TO PARTICIPATE IN:

- () Public Service Events
- () RACES or ARES Emergency services
- () Field day, other operating events
- () Helping with SCRA Flea Market
- () Acting as club Net Control Station
- () Helping with *Short Skip* newsletter
- () Taking a Novice class
- () Teaching a Novice class
- () Taking an upgrade class
- () Teaching an upgrade class
- () Other _____

Badge (New Members only)

Fill in this section exactly as you want it to appear on your badge.

Callsign _____

First Name _____

City _____

DEC 1994



NEWS of Amateur Radio

by Brad Wyatt K6WR
ARRL Div. Director

Congressional Legislative Report (BIG NEWS!):

The BIG NEWS is that President Clinton signed Public Law 103-408 (Senate Joint Resolution 90) into law on Oct. 22, 1994.

The language of the new law asks all government entities to support, as national policy, "reasonable accommodation" in the operation of Amateur Radio stations in homes, automobiles and public places. We would not have gotten this far without your grassroots letter writing and personal contact support to help the Washington activities by ARRL!

The next step is to get House Resolution 4522, the FCC Authorization Act of 1994, passed by the Senate on Nov. 29/30, 1994, in the lame duck session of

Congress. The House passed the bill in the closing hours of the session on Oct. 7 before leaving for the election campaign. Keep your fingers crossed. There is a great deal of behind the scenes work going on by the ARRL and many others.

HR 4522 contains various technical provisions desired by the FCC and other provisions desired by ARRL, including one related to "vanity calls." Congress had previously authorized a \$7 per year fee for "vanity calls," but in HR 4522 it is changed to a ONE TIME application fee of \$150. If both these items become law, 1994 will go down in history as a banner year for Amateur Radio in terms of long term national support for our service!

Again, many thanks for all the 1994 grassroots work!

Brad Wyatt K6WR, ARRL Pacific Div Director,
18400 Overlook Rd #5, Los Gatos, CA 95030-5850
408-395-2501 Packet: K6WR@NOARY.#NOCAL.CA
Internet: bwyatt@arrl.org ■

PLEASE DO NOT DELAY
DATED MATERIAL:

MICHAEL P VONDER PORTEN
KD6ZZD
1815 MANOR DR
SANTA ROSA, CA 95403

ADDRESS CORRECTION REQUESTED

Sonoma County Radio Amateurs, Inc.
PO Box 116
Santa Rosa, CA 95402

BULK RATE
U.S. POSTAGE PAID
SANTA ROSA, CA
PERMIT NO. 658