

Sonoma County Radio Amateurs, Inc.

Club Station
W6LFJ

P.O. Box 116
Santa Rosa, CA 95402

Repeater Station
WB6PVS



Vol. 9

Nr. 4-84

D F MOVES INTO YOUR LIFE

AMATEURS AS A WHOLE ARE CONTENDING WITH MORE INTERFERENCE EVERY DAY OF YOUR OPERATING LIFE. SOME OF THIS IS INTENTIONALLY CAUSED BY FELLOW AMATEURS. SOME IS CAUSED BY INTERMOD OR FREQUENCIES MIXING WITH OTHER FREQUENCIES AND ENDING UPON THE INPUT OF YOUR LOCAL REPEATER. ANOTHER INTERFERENCE FOUND LOCALLY IS JUST A GOB OF GARBAGE LIKE AN ARC WELDER BUT DIFFERENT, AND IT ENTERS THE REPEATER. ANY OF THE ABOVE BRING UP THE NEED OF D. F..

BY THE HELP OF D. F. OR DIRECTION FINDING SOME OF THE PROBLEMS MAYBE FOUND AND WITH THE ADDITIONAL HELP OF THE FCC SOME MAYBE TERMINATED.

THE TWO DRAWINGS IN THIS ISSUE OF SHORT SKIP ARE THE WORK OF BRIAN KOTZIAN, KE6WL. BRIAN HAD THE PROBLEM OF LAST PLACE IN TOO MANY TURKEY HUNTS SO THE CIRCUITS ARE A RESULT OF MOVING FROM LAST PLACE TO FIRST PLACE. HIS ELAPSED TIME FROM START TO LOCATION OF THE LAST TURKEY WAS 28 MINUTES. DRIVING TIME WOULD BE ABOUT THE SAME AMOUNT OF TIME.

BRIAN EXPLAINED THE WORKING OF THE UNIT AT THE LAST CLUB MEETING SO WILL NOT GO INTO ALL OF THAT HERE. IF YOU ARE INTERESTED ALL PARTS ARE AVAILABLE AT RADIO SHACK AND HALTECH. THERE IS NO PC BOARD LAYOUT AT PRESENT BUT MAYBE THAT CAN COME LATER IF MEMBERS ARE INTERESTED IN CONSTRUCTION OF THIS PROJECT IN LARGE NUMBERS. ED.

AS IN THE PAST THE WINNER OF THE LAST HUNT WILL BE THE NEXT FOX OR TURKEY IN THE NEXT HUNT. SO BRIAN WILL BE THE NEXT OBJECT TO FIND AND HE IS GOING TO BE A FOX AS HE IS TIRED OF BEING A TURKEY. SO ON SATURDAY APRIL THE 14th AT 2:00 PM STARTING AT RALEY'S IN WINDSOR BE READY FOR THE HUNT. GOOD LUCK AND GET IN SOME GOOD PRACTICE AND WIN....

PG. 2

- 1984 OFFICERS.....
- PRESIDENT.....JIM TOMER...W6CYM
838-9464
- V. PRESIDENT..DOUG BENDER...WAØJBR
526-5131
- SECT.....KATHY BOYETT...WB6UAZ
544-7943
- TRES.....BILL MEYERS...K6TCD
539-1489
- BOARD MEMBER
- AT LARGE.....CHUCK SABIN...N6DDK
795-2371
- ACTIVITIES....STEVE SCHAFFER...KD6GC
546-8860
- REPEATER
- CHAIRMAN.....AL BLOOM...N1AL
838-4524
- SHORT SKIP....HANK DAVIS...W6DTV
SARAH DAVIS...N6FAX
823-7885
- RACES LIAISON..JIM BOYETT...WB6UBA
544-7943

CLUB REPEATER..WB6PVS..146.73..CLUB STATION
W6LFJ..NET EVERY TUESDAY 7PM..146.73
CLUB MEETS FIRST WED. EACH MONTH EXCEPT DEC.
PLACE IS OFFICE OF EMERGENCY SERVICES PLANNING
ROOM, SANTA ROSA, CA.
MAILING ADDRESS..P.O.BOX 116..SANTA ROSA, CA.
95402.
RACES MEETS FIRST MONDAY AND THIRD MONDAY OF
EACH MONTH, 7PM ON LOCAL SIMPLEX FREQUENCY.
ADIM. FREQUENCY 146.73 AT 7:30 PM.

THE FOLLOWING ARE IN CHARGE OF LISTED ACTIVITY:
REFRESHMENTS AT MEETINGS: BOB OLSTEN
RAFFLE CHAIRMAN: LYMAN WILTSHIRE, TERRY LADUKE
CONDUCTS.
CLUB PICNIC: STEVE SCHAFFER
CHRISTMAS PARTY: DOUG BENDER, SCHAFFER ADV.
FLEA MARKET: AL BLOOM
FIELD DAY: TERRY LADUKE, STEVE LUND, CHUCK
SABIN
EDUC. COMM: GEORGE SHEDORE, LEN GERALDI
HOMEBREW CONTEST: STEVE LUND
WALKATHONS: AL SCHMIDT, CHUCK SABIN, AL BLOOM
PROGRAM CHAIR: AL SCHMIDT
GREETINGS AT MEETINGS: PAT SCHAFFER
POT LUCK: DON AND IRMA, OSBORNE/PEMBERTON
HIDDEN XMTR: AL SCHMIDT, TERRY LA DUKE NEXT
HIDDEN XMTR.
QSL MANAGER: JIM TOMER

ARRL PUP. ARRIVED →

"DE W6CYM" HOT DAMN.....

MEMBERSHIP IS INCREASING! MEMBERSHIP PART-
ICIPATION IS ON THE UPSWING! THE EDUCATIONAL PRO-
GRAMS ARE IN FULL SWING! FUND RAISING AND SOCIAL
PROGRAMS ARE WELL UNDER WAY!

AND IT IS ALL YOUR FAULT"

REMEMBER, THE CLUB IS ONLY AS GOOD AS YOU
MAKE IT. LETS HAVE YOUR SUGGESTIONS AND CRIT-
ICISMS. HELP THE COMMITTEE CHAIRMEN WITH THEIR
PROGRAMS. MANY HANDS MAKE LIGHT WORK. GET YOUR
FEET WET!

THE "HOME BREW" CONTEST TAKES PLACE AT THE
APRIL MEETING. ENTER SOMETHING EVEN IF ITS ONLY
A WELL DONE SOLDER JOINT. THERE WILL BE AWARD
END OF QRM. SIG. JIM

HERE IT IS..THIS WILL FLIP YOU...AT THE LAST
OUTING OF THE MOBILEERS A FRIEND OF LYMAN WB6SMY
EDNA BEQUEAITH, SERVED A RELISH FOR THE BURGERS
AND DOGS THAT WAS REAL GOOD AND SEVERAL OF THOSE
PRESENT WANTED THE GOODS SO HERE IT IS IN A
RADIO NEWS PAPER. HI HI ED.
ZUCCHINI RELISH

MAKES 7 TO 9 PTS.

- 20 CUPS GROUND OR GRATED ZUCCHINI
- 8 CUPS GROUND OR GRATED ONIONS
- 2 GREEN AND 2 RED PEPPERS, GROUND OR GRATED

PUT IN LARGE BOWL OR KETTLE. SPRINKLE 3 TBS
SALT OVER IT, AND LET STAND OVERNIGHT. DRAIN
AND RINSE IN COLD WATER.

BLEND TOGETHER ALL DRY INGREDIENTS:

- 4½ CUPS SUGAR
- 1 TSP EACH PEPPER, CELERY SALT OR SEED, NUTMEG
TUMERIC, MUSTARD
- 3TBS CORNSTARCH
- ADD TO GROUND MIXTURE AND ADD:
- 2 1/4 CUPS CIDER VINEGAR
- HEAT TO BOILING POINT. PUT IN JARS AND
SEAL.

(I SOMETIMES USE GRATED CARROTS TO GIVE
SOME COLOR. ALSO, IF I HAVE MORE THAN 4 PEPPERS
I PUT THEM IN.

ENJOY! EDNA BEQUEAITH

NOW YOU CAN NOT SAY THAT SHORT SKIP DOES
NOT COVER EVERYTHING. ED.

GEO KS6W JUST INFORMED ME THAT SAWYERS
NEWS HAS ARRL PUBLICATIONS IN STOCK. AT LAST
A LOCAL SUPPLY AGAIN AFTER MANY YEARS.

Sawyers News Inc.

711-4th St Santa Rosa. Ca.

542-1311

W5YI REPORT

FCC GIVES INSTRUCTIONS TO NEW VECs.....

THE FCC HAS ISSUED INSTRUCTIONS TO THE FIVE NEWLY APPOINTED VOLUNTEER EXAMINER COORDINATORS (VECS) EXPLAINING TO THEM THE STEPS THEY ARE TO TAKE NOW THAT THEY HAVE BEEN APPOINTED TO COORDINATE THE EFFORTS OF VOLUNTEER EXAMINERS IN ADMINISTERING AMATEUR RADIO OPERATOR LICENSES.

CONTACT WITH THE FCC.....

THE VEC SHOULD NAME A CONTACT PERSON AND AN ALTERNATE TO CONDUCT DAY-TO-DAY COMMUNICATIONS WITH THE FCC. ONE OF THESE INDIVIDUALS MUST BE AVAILABLE DURING NORMAL BUSINESS HOURS TO ANSWER QUESTIONS THAT MAY ARISE DURING THE PROCESSING OF APPLICATIONS FORWARDED TO THE FCC BY THE COORDINATOR.

THE FCC ASKED THE NEW VECs TO TRY TO RECRUIT AMATEUR EXTRA CLASS OPERATORS AS VEs "SINCE THEY CAN ADMINISTER ALL EXAMINATIONS." ADVANCED CLASS OPERATORS CAN ADMINISTER ONLY THE TECHNICIAN CLASS EXAMINATIONS. NO OTHER CLASS OF LICENSEE CAN PARTICIPATE IN THE PROGRAM.

OTHER VE QUALIFICATIONS THAT THE FCC INSISTED ON WAS THAT.....,
A VE MUST HAVE A CURRENT EXTRA CLASS OR ADVANCED LICENSE..MUST NOT HAVE EVER HAD HIS/HER AMATEUR LICENSE REVOKED OR SUSPENDED...AND MUST NOT OWN A SIGNIFICANT INTEREST IN OR BE AN EMPLOYEE OF A COMPANY OR ENTITY ENGAGED IN THE MANUFACTURE OR DISTRIBUTION OF AMATEUR RADIO EQUIPMENT OR ENGAGED IN THE PREPARATION OR DISTRIBUTION OF LICENSE TESTING MATERIAL.

UNIQUE IDENTIFIER CODES.....

WERE ORDERED ESTABLISHED FOR EACH EXAMINATION SESSION COORDINATED BY THE VEC. THERE ARE 90 IDENTIFIERS TO SELECT FROM: WA THROUGH WZ, KA-KZ, NA-NZ, AND AA THROUGH AL. THE FCC SAID THAT ANY IDENTIFIER COULD BE REUSED AFTER 90 DAYS. "SHOULD YOU NEED TO COORDINATE MORE THAN 360 EXAMINATION SESSIONS PER YEAR YOU MAY ADD A NUMBER AFTER THESE LETTERS. THE SAME LETTERS ARE USED IN ALL CALL AREAS.

CERTIFICATES OF SUCCESSFUL EXAMS.....

VOLUNTEER EXAMINERS WILL ISSUE EACH CANDIDATE THAT SCORES A PASSING AMATEUR RADIO TEST GRADE A "CERTIFICATE OF SUCCESSFUL COMPLETION OF EXAMINATION." THESE CERTIFICATES SERVE TWO FUNCTIONS: TELEGRAPHY ELEMENT CREDIT (WHEN A CANDIDATE PASSES THE HIGHER CLASS CW REQUIREMENT BUT FAILS THE REQUIRED WRITTEN TEST) AND TEMPORARY OPERATION AUTHORITY.

THE POSSESSION OF THE CERTIFICATE VALIDATES TEMPORARY OPERATION WITH THE RIGHTS AND PRIVILEGES OF THE HIGHER CLASS UNTIL THE NEW LICENSE IS RECEIVED OR FOR A PERIOD OF 90 DAYS, WHICHEVER COMES FIRST.

THE FCC ADVISED EACH VEC THAT THE CERTIFICATE COULD BE MADE UP BY THEM BUT THAT ".... CARE MUST BE TAKEN TO DISCOURAGE ALTERATION OR IMITATION." EACH CERTIFICATE ISSUED MUST CONTAIN:

1. RECIPIENT'S NAME,
2. AMATEUR CALL SIGN (IF AVAILABLE),
3. TELEGRAPHY ELEMENT SUCCESSFULLY COMPLETED,
4. OPERATOR CLASS SUCCESSFULLY COMPLETED
5. EXAMINATION SESSION IDENTIFIER,
6. DATE EXAMINATION SUCCESSFULLY COMPLETED,
7. SIGNATURE OF EACH OF THE 3 VOLUNTEER EXAMINERS ADMINISTERING THE EXAM,
8. AMATEUR CALL SIGN OF EACH VE.

THE COMMISSION SAID THAT THE VECs COULD PROVIDE COPIES OF THE APPLICATION FORM (FCC FORM 610) AND THAT THEY COULD BE DUPLICATED FROM FCC COPIES. (CURRENT VERSION IS DATED: DECEMBER 1981.0 "UNTIL THE NEW FORM 610 IS AVAILABLE, (THIS VERSION) MUST BE USED TOGETHER WITH A TEMPORARY FCC FORM 610 ATTACHMENT." THIS ATTACHMENT IS USED BY THE VEs FOR THE EXAMINERS REPORT (SECTION I) AND EXAMINERS CERTIFICATION (SECTION II-B.) THE ATTACHMENT FORMS CAN ALSO BE DUPLICATED, THE FCC SAID.

EACH APPLICATION RECEIVED BY THE VEC MUST BE DATE STAMPED AND SCREENED FOR COMPLETENESS AND AUTHENTICITY.

1. VERIFY THAT THE VEs HAVE BEEN ACCREDITED BY YOUR ORGANIZATION.
2. MAKE CERTAIN THE TEAM REPORT ON THE FCC FORM 610 ATTACHMENT IS CORRECTLY FILLED OUT AND REQUIRED ELEMENTS PASSED.
3. ve certification must be properly filled out on the application.
4. A PHOTOCOPY OR ORIGINAL OF THE LICENSE MUST BE ATTACHED.

OLD BUSINESS

Generator License: The license for our generator was received in the mail this past week.

Contributions from Radio Shack: It was noted that Zane, WB6SRU, makes considerable contributions from his Radio Shack dealership on Farmers Lane each month for our raffle prizes. It was suggested that if we need to do business with Radio Shack that we try to do it at his store.

Novice Round-Up Contest Logs are needed by Steve, WASLLY, to determine the winner within our Club.

NEW BUSINESS

Swap Meets: two swap meets were mentioned:

1. Saturday, March 10, at Foothill College.
2. Saturday, March 17, at Ukiah. Information on 146.67.

Novice Station Equipment needed: Pat, KB6DYL, is looking for equipment to set up his Novice station. It was suggested that he contact Chuck Ternes of Ternes Office Supply Company. He listed some equipment on the Swap Shop for \$65.00 that would make a good Novice station.

Card of Thanks: A card was received from the Busch family thanking us for our concern at the passing of Dave, WA6KXH/KF6RT.

Jerry Jensen: It was mentioned that Jerry Jensen, KB6VD, who is a local newscaster, is dying of cancer. It was suggested that we send him QSL cards.

Volunteer Examiner Forms: Those that have volunteered to be examiners have been sent forms requiring references from ten other amateur radio operators. If these forms are brought to the Club meeting, signatures can easily be obtained.

Cookies: Thanks was expressed for the cookies at tonight's meeting sent by the YL of Jim, KA6BYX.

PROGRAM

The program tonight was presented by Brian, KE6WL. He explained the antenna system that he used in last month's transmitter hunt. A schematic will be given to Hank to publish in Short Skip for those who are interested. He brought in the antenna and unit for inspection.

The next Fox Hunt will be held on Saturday, April 14. Meet at 2:00 in the parking lot at the Raley's in Windsor.

Al, KD6NT, sent in the video entitled, "At Any Moment," which explains the role of amateur radio operators to the community in time of disaster and for service related events.

The Membership Lottery was won tonight by Frank, WA6PXW. The total amount in the fund was \$27.95. Congratulations, Frank (and Helen)!!!

The Raffle brought in \$39.00 tonight.

Raffle for 813 Linear Amplifier: A special raffle was held for a 813 Linear Amplifier. It brought in \$27.00 for the Club and was won by Chuck, N6DDK, (who sold it to Brian, KE6WL, for \$10.00).

The meeting was adjourned at 9:15.

-- Kathi Boyett, WB6UAZ, Secretary

MINUTES OF THE MARCH, 1984 GENERAL MEETING
(SUBJECT TO APPROVAL AT THE APRIL MEETING)

The General Club Meeting was held on March 7, 1984 at the Emergency Operations Center of the County Administration Center and was called to order at 7:33 by our President, Jim, W6CYM.

The following Visitors were introduced: Pat, KB6DYL; Wally, KN6NDC; JoAnn, attending Novice Class.

The Minutes of the February Meeting were approved. (Moved by N6DDK, seconded by KH6GJV, voted by the Club.)

The Treasurer's Report was as follows: General Fund - beginning balance was \$790.80, ending balance was \$1,368.31. Repeater fund remained unchanged with a balance of \$817.62. (Moved by KA6BYX, seconded by W8LLY, voted by the Club.)

COMMITTEE REPORTS

Refreshment Committee: The Club was given a choice of purchasing either decaffeinated or regular coffee. A show of hands indicated that we stay with the regular coffee. Doug, WA0JRB, volunteered to bring a small percolator for hot water and those wishing to drink other than regular coffee could make their own drink.

Repeater Committee: Al, N1AL, reminded the Club that we are still trying to sell our 6-meter repeater. If anyone knows of an interested party, pass the word along.

Activities Committee:

1. A Transmitter Hunt was held on February 25. Terry, WA6RNF, was the Rabbit this time. Brian, KE6WL, came in first finding the location in 28 minutes.
2. The Home Brew Contest will be held at our next General Meeting on April 4.
3. The March of Dimes Walk-A-Thon will be held on April 29.

Communications Trailer: We received five bids on the trailer. Don, WA6ACX, purchased it for \$326.00.

Education Committee:

1. The Novice Class conducted by George, KS6W, has approximately 25-29 attending. Last week four people passed their code test.
2. The Up-Grade Class conducted by Al, N1AL, has approximately 8-10 attending.
3. There is a Novice class being held in Penngrove with 3 attending.

Badge Committee: Those badges that have been received were distributed.

Clipperton DX Expedition: Lyle, N6BLN, will be going to the Clipperton Islands on a DX Expedition. He will be on the air beginning next Wednesday, March 17, on all bands phone and CW 10-160 meters. If you move up 5 KHz and give him a call, he will give Sonoma County special attention. He will be there one week. The calls used will have the prefix F00???

QSL Committee: There has been no activity. It was mentioned that a rubber stamp with the Club name and return address was needed for the QSL cards. The Club agreed to purchase such. (Moved by W6CYM, seconded by N1AL, voted by the Club.)

Sympathy Expressed to N6FQZ: It was noted that Jack's wife had passed away. A card was sent around for the club membership to sign.

PR Committee: It was noted that Van, N6GFY, who is chairman of this committee was not present because of a fall and blow to his head. It is hoped that he heals soon.

Field Day: Pete Peterka feels there should be no problem with us securing Ragle Park again this year as our Field Day site. If there are problems, he assures us that another location within the county will be provided for our use.

SONOMA COUNTY RADIO AMATEURS, INC.
 1984 CLUB MEMBERSHIP ROSTER
 (Full and Sponsoring Members)

CALL	NAME	ADDRESS	CITY, STATE	ZIP	PHONE
WB6ACJ	RAY CLARY, JR.	1728 REIFLING	LODI, CA	95248	(209) 369-9224
WA6ACX	DON OSBORNE	9878 GREEN VALLEY ROAD	SEBASTOPOL, CA	95472	829-8568
KF6AG	PAT SCHAFFER	2328 MARK WEST SPRINGS ROAD	SANTA ROSA, CA	95484	546-8868
M1AL	AL BLOOM	268 ARATA LANE	WINDSOR, CA	95492	838-4524
K6ANP	LEN GERALDI	9785 OLD REDWOOD HIGHWAY	PENNGROVE, CA	94951	795-4335
N68BI	JOSEPH HOFFMANN	3828 JOY ROAD	OCCIDENTAL, CA	95465	874-3269
WA6BHX	RAYMOND CLARY, SR.	2125 E. FOOTHILL DRIVE	SANTA ROSA, CA	95484	546-3737
H7BMZ	H. L. CLARK	7788 SONOMA HIGHWAY	SANTA ROSA, CA	95485	
W68HB	ROBERT L. SHRADER	11911 BARNETT VALLEY ROAD	SEBASTOPOL, CA	95472	823-9122
K68WX	R. H. MADDUX	2435 MURDOCK DRIVE	SANTA ROSA, CA	95484	578-8825
KA6BYX	JAMES H. HOBART	2853 HUMBOLDT STREET	SANTA ROSA, CA	95484	546-3225
KF6CA	TERRY PANNETT	5961 YERBA BUENA ROAD	SANTA ROSA, CA	95485	539-7715
W6CCY	JOHN P. LYNCH	6718 NICOLE COURT	SEBASTOPOL, CA	95472	823-1357
N6CGE	TODD BENDT	7299 CIRCLE DRIVE	ROHNERT PARK, CA	94928	795-8535
WD6CKP	HENRY "HOPPY" BRAVIN	3411 COFFEY LANE	SANTA ROSA, CA	95481	542-6758
W6CYM	JIM TONER	789 SEQUOIA DRIVE	WINDSOR, CA	95452	838-9464
K6DCJ	ALAN GERALDI	9785 OLD REDWOOD HIGHWAY	PENNGROVE, CA	94951	795-4335
N6DDK	CHUCK SABIN	8345 BRAND LANE	PENNGROVE, CA	94951	795-2371
KA6DEI	TERRY LYNCH	6718 NICOLE COURT	SEBASTOPOL, CA	95472	823-1357
KB6DIO	PHIL COPENHAVER	48 LARK CENTER DRIVE, #2	SANTA ROSA, CA	95481	539-6162
N6DIP	FRANCIS J. RALPH	981 WASHINGTON STREET	CALISTOGA, CA	94515	
KA6DJY	JOHN KOBOLD	2433 APPLETREE DRIVE	SANTA ROSA, CA	95481	544-5338
KB6DNC	CAROLYN O'NEILL	15 ROCCA DRIVE	PETALUMA, CA	94952	762-8468
WD6DPE	BOB OLSTEN	3723 ARIZONA DRIVE	SANTA ROSA, CA	95485	546-5593
KB6DQD	R. L. MAPPUS	374 SPRAVEN ROAD	PETALUMA, CA	94952	664-1978
KB6DRS	MAPPUS, MARIE	374 SPRAVEN ROAD	PETALUMA, CA	94952	664-1978
N6DSW	GEORGE WALLACE	115 PAYTON	PETALUMA, CA	94952	762-8688
W6DTV	HENRY "HANK" DAVIS	7822 WASHINGTON AVENUE	SEBASTOPOL, CA	95472	823-7885
WD6DXV	BILL THOMAS	5341 THOMAS ROAD	SEBASTOPOL, CA	95472	823-9429
W6DZM	DONALD E. CHRISTENSEN	2218 OAK HILL DRIVE	SANTA ROSA, CA	95484	545-2241
N6FAX	SARAH DAVIS	7822 WASHINGTON AVENUE	SEBASTOPOL, CA	95472	823-7885
W6FPL	SEYMOUR MALMUTH	28738 TEMELEC DRIVE	SONOMA, CA	95476	996-5812
N6FQZ	JACK GUGGOLZ	1123 PALOMINO ROAD	CLOVERDALE, CA	95425	894-5798
KF6FX	IRMA PEMBERTON	9878 GREEN VALLEY ROAD	SEBASTOPOL, CA	95472	829-8565
KB6GC	STEVE SCHAFFER	2328 MARK WEST SPRINGS ROAD	SANTA ROSA, CA	95484	546-8868
N6GFY	J.C. VAN GROOS	1789 PAMELA DRIVE	SANTA ROSA, CA	95484	544-3485
KH6GJV	BILL HILLENDAHL	P. O. BOX 4151	SANTA ROSA, CA	95482	539-2791
N6GX1	KEN MORTON	488 NANNET AVENUE	SANTA ROSA, CA	95481	584-8834
W6GYV	JAMES T. HALL	28747 TEMELEC DRIVE	SONOMA, CA	95476	938-1559
N6GZV	MAY KOBOLD	2433 APPLETREE DRIVE	SANTA ROSA, CA	95481	544-5338

CALL	NAME	ADDRESS	CITY, STATE	ZIP	PHONE
KA6HGW	BART HOLMES	2818 COCHINA COURT	SANTA ROSA, CA	95481	528-3955
KD6IB	PAUL R. PHILLIPS	151 ALDERBROOK DRIVE	SANTA ROSA, CA	95485	546-6986
W6IY	BRIAN TORR	28221 ALDER ROAD, P. O. BOX 28	MONTE RIO, CA	95462	865-2234
W6IRJ	SUSAN SCHUYLER	P. O. BOX 222	KENWOOD, CA	95452	833-6828
KA6JHM	DAN GERALDI	9785 OLD REDWOOD HIGHWAY	PENNGROVE, CA	94951	795-4335
WB7JBP	MATTHEW J. WALSH	485 PETERSON LANE	PETALUMA, CA	94952	
WA6JRB	DOUG BENDER	3638 HEMLOCK COURT	SANTA ROSA, CA	95481	526-5131
WA6JTB	RUSSELL O'NEILL	15 ROCCA DRIVE	PETALUMA, CA	94952	762-8468
W6JXZ	JOHN DeMUTH	8862 OAK TRAIL PLACE	SANTA ROSA, CA	95485	833-4688
W6KHO	CHARLES K. JACKSON	P. O. BOX 393	BODEGA BAY, CA	94923	875-2438
W6KIT	TOM SEHABIAGUE	2781 WARM SPRINGS ROAD	GLEN ELLEN, CA	95442	525-1751
WB6KXN	WALTER FRANSON	5325 MARIT DRIVE	SANTA ROSA, CA	95485	539-4894
W6LCZ	KEN W. CHRISTENSEN	2615 RANCHO CABEZA DRIVE	SANTA ROSA, CA	95484	542-2716
W6LGB	ART HAGOPIAN	34 LAUREL AVENUE	PETALUMA, CA	94952	762-2132
KD6LL	WALTER KELEHER	136 BIDWELL WAY	VALLEJO, CA	94589	642-8481
WA8LLY	STEVE LUND	1855 JENNINGS AVENUE	SANTA ROSA, CA	95481	526-6197
W6LOU	FRED PLANTE	18828 SKY COURT, CLR	KELSEYVILLE, CA	95451	277-7377
WB6HFL	HAROLD "PAPPY" FROELICK	228 FARTHILL DRIVE	OROVILLE, CA	95965	(919) 533-6915
W6MHJ	DICK FIGUERE	2412 FOOTHILL BOULEVARD, SPACE 161	CALISTOGA, CA	94515	942-5893
K6MUP	HOPPY HOPKINS	3982 VINEHILL ROAD	SEBASTOPOL, CA	95472	823-7182
K6MZ	LYLE ANDERSON	18625 CANYON ROAD	FORESTVILLE, CA	95436	887-2166
KD6NT	AL SCHMIDT	2779 LESLIE ROAD	SANTA ROSA, CA	95484	542-4793
W6NTZ	RALPH E. JOHNSON	885 CRINELLA DRIVE	PETALUMA, CA	94952	763-9616
W6OH	WALTER BRUNN	131 SUNNYSLOPE ROAD, P. O. BOX 283	PETALUMA, CA	94952	763-8476
AC8P	DENNIS DERICKSON	3844 CRESTVIEW DRIVE	SANTA ROSA, CA	95481	542-1541
K6PCX	ROBERT W. MILLER	158 CALLE DEL SOL	BODEGA BAY, CA	94923	875-3733
W6PER	JIM RUTHERFORD	P. O. BOX 222	KENWOOD, CA	95452	833-6828
W6QP	LAUREN TUDOR	P. O. BOX 2444	ARNOLD, CA	95223	(289) 795-4777
WB6RHP	WARREN KLINGER	P. O. BOX 23	JENNER, CA	95458	632-5459
WA6RNF	TERRY LaDUKE	1512 PLUMERIA DRIVE	SANTA ROSA, CA	95481	528-6412
K6ROP	VERNON C. MILLER	551 CLEMENT AVENUE	SANTA ROSA, CA	95481	545-5185
KA6RQK	JUDY LaDUKE	1512 PLUMERIA DRIVE	SANTA ROSA, CA	95481	528-6412
KN6S	GEORGE LEFFINGWELL	1945 PINER ROAD	SANTA ROSA, CA	95481	523-2436
WB6SMY	LYMAN WILTSHIRE	1888 ADOBE CANYON ROAD	KENWOOD, CA	95452	833-2888
K6SED	LOWELL M. LUX	4567 BRIGHTON DRIVE	SANTA ROSA, CA	95481	546-7899
K6TCD	BILL MEYER	6516 MEADOWGREEN PLACE	SANTA ROSA, CA	95485	539-1489
WB6THY	WARREN REESE	P. O. BOX 4694	SANTA ROSA, CA	95482	527-8124
WB6UAZ	KATHI BOYETT	1326 DOGWOOD DRIVE	SANTA ROSA, CA	95481	544-7943
WB6UBA	JIM BOYETT	1326 DOGWOOD DRIVE	SANTA ROSA, CA	95481	544-7943
WA6UCP	BUD LOCKWOOD	918 JACK LONDON DRIVE	SANTA ROSA, CA	95485	539-1579
KS6W	GEORGE SHEDORE	2847 BLUEBELL DRIVE	SANTA ROSA, CA	95481	528-8281
KE6WL	BRIAN KOTZIAN	2681 McBRIDE LANE, #4	SANTA ROSA, CA	95481	528-3884
W6VXU	SAM SULLIVAN	28565 5TH STREET, EAST	SONOMA, CA	95476	938-4197
KD6XF	CLIFFORD BARTLETT, JR.	35 MISSION DRIVE	PETALUMA, CA	94952	763-2119
K6XZ	ROBERT CRAIG	5519 EL ENCANTO CIRCLE	SANTA ROSA, CA	95485	539-8316

DF UNIT

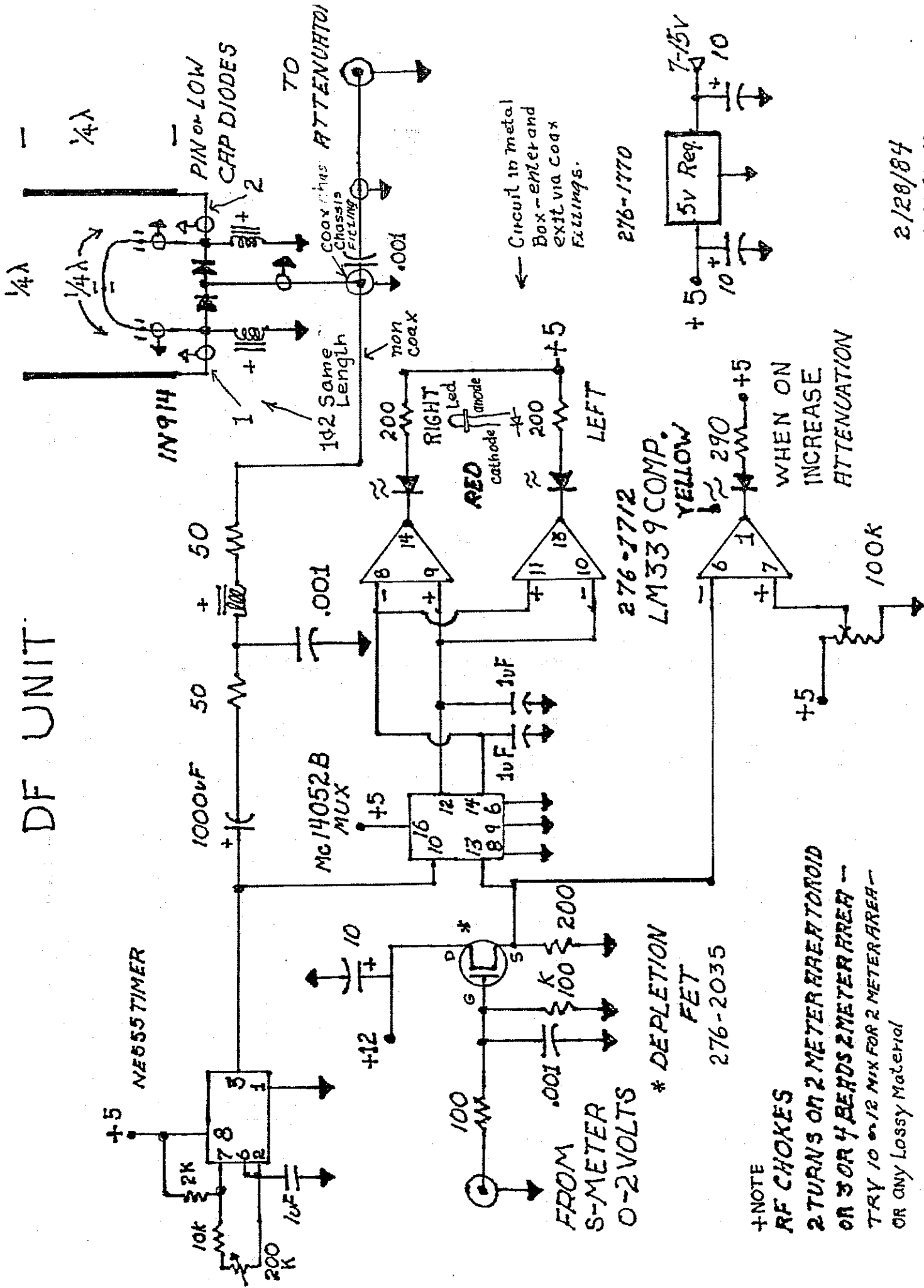

+NOTE
 RF CHOKES
 2 TURNS ON 2 METER AREA TOROID
 OR 3 OR 4 BEADS 2 METER AREA --
 TRY 10 or 12 MIX FOR 2 METER AREA --
 OR ANY Lossy Material

* DEPLETION
 FET
 276-2035

FROM
 S-METER
 0-2 VOLTS

WHEN ON
 INCREASE
 ATTENUATION

276-2712
 LM339 COMP.
 YELLOW

276-1770

← Circuit in metal
 Box - enter and
 exit via coax
 fittings.

2/28/84
 KE6WLL

DF UNIT BLOCK DIAGRAM

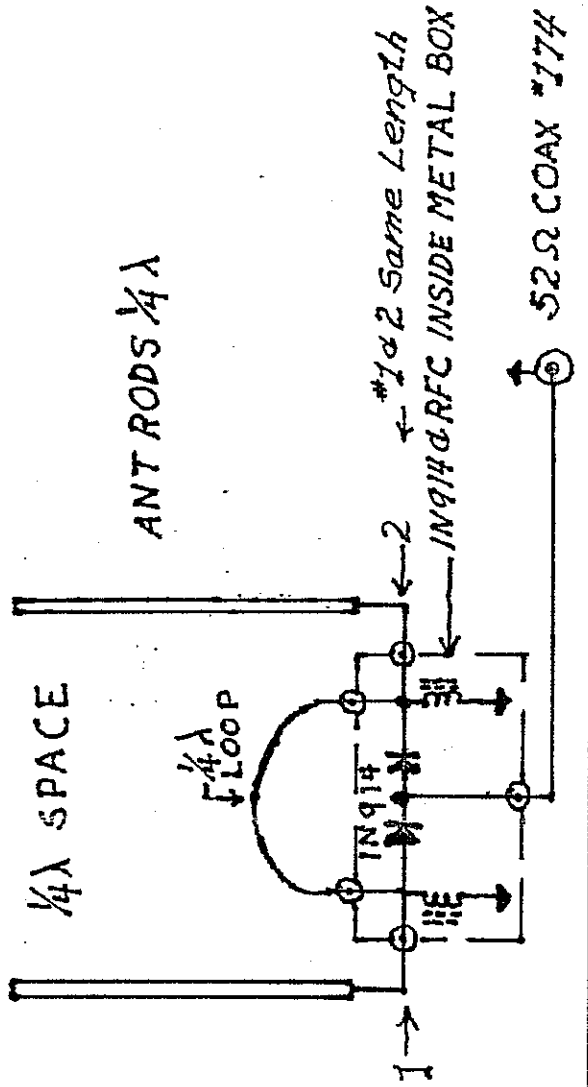
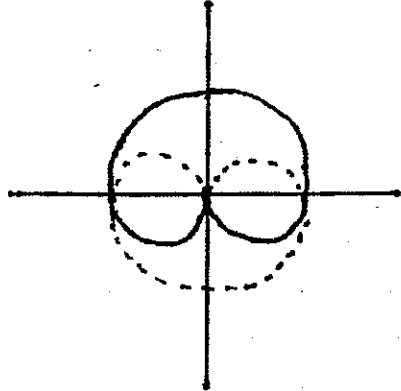
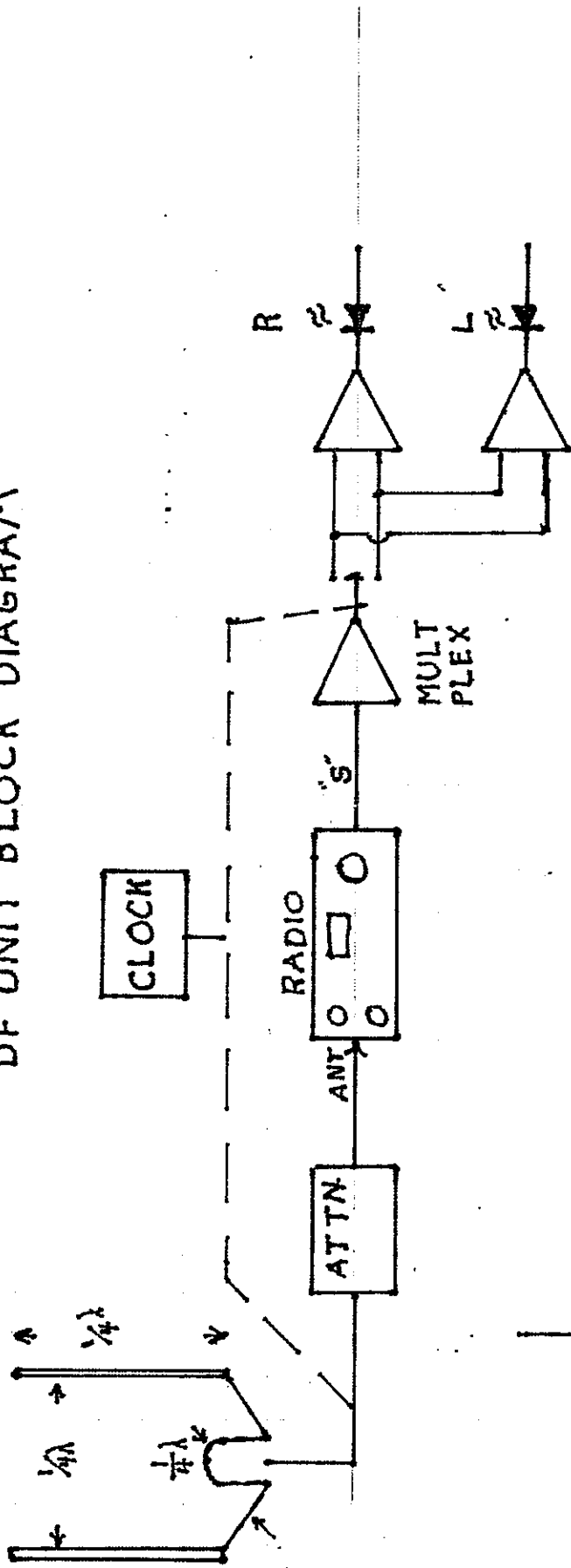

2/28/64
KE6WL

HOME BREW CONTEST

Bring your latest creation to the April meeting for the third annual SCRA Homebrew Contest. You do not have to be an electrical engineer to win this one. Don't forget that the winner's name is added to the plaque in the club's trophy case. The judges will be Steve, W8LLY and Al, N1AL.

RULES

1. Contest is open to SCRA members only.
2. Schematics or program listing must be supplied.
3. No kits unless significant modifications have been made.
4. Project must be amateur radio related.
5. The equipment or program listing must be brought to the club meeting on the contest night. Exceptions will be made for large projects, such as antennas. In such cases bring a photo or other documentation.
6. Proof of operation shall constitute plugging the gear in and operating it. Otherwise submit test data to show that it works as intended.
7. The winner will receive a certificate, and his name will be engraved on the SCRA homebrew contest plaque.

ENTRY FORM

Name _____

Project _____

JUDGING CRITERIA

Circuit complexity and sophistication of function	_____ (15)
Novelty, ingenuity, economy of operation (original designs only)	_____ (10)
Proof of operation	_____ (15)
Utility and operation convenience	_____ (10)
Neatness, appearance, workmanship	_____ (20)
Use of surplus and/or readily available parts	_____ (15)
Judges' discretion	_____ (15)
TOTAL	_____ (100)

RADIO AMATEUR FREQUENCY ALLOCATIONS

(Mar. 1, 1984; frequencies in MHz)

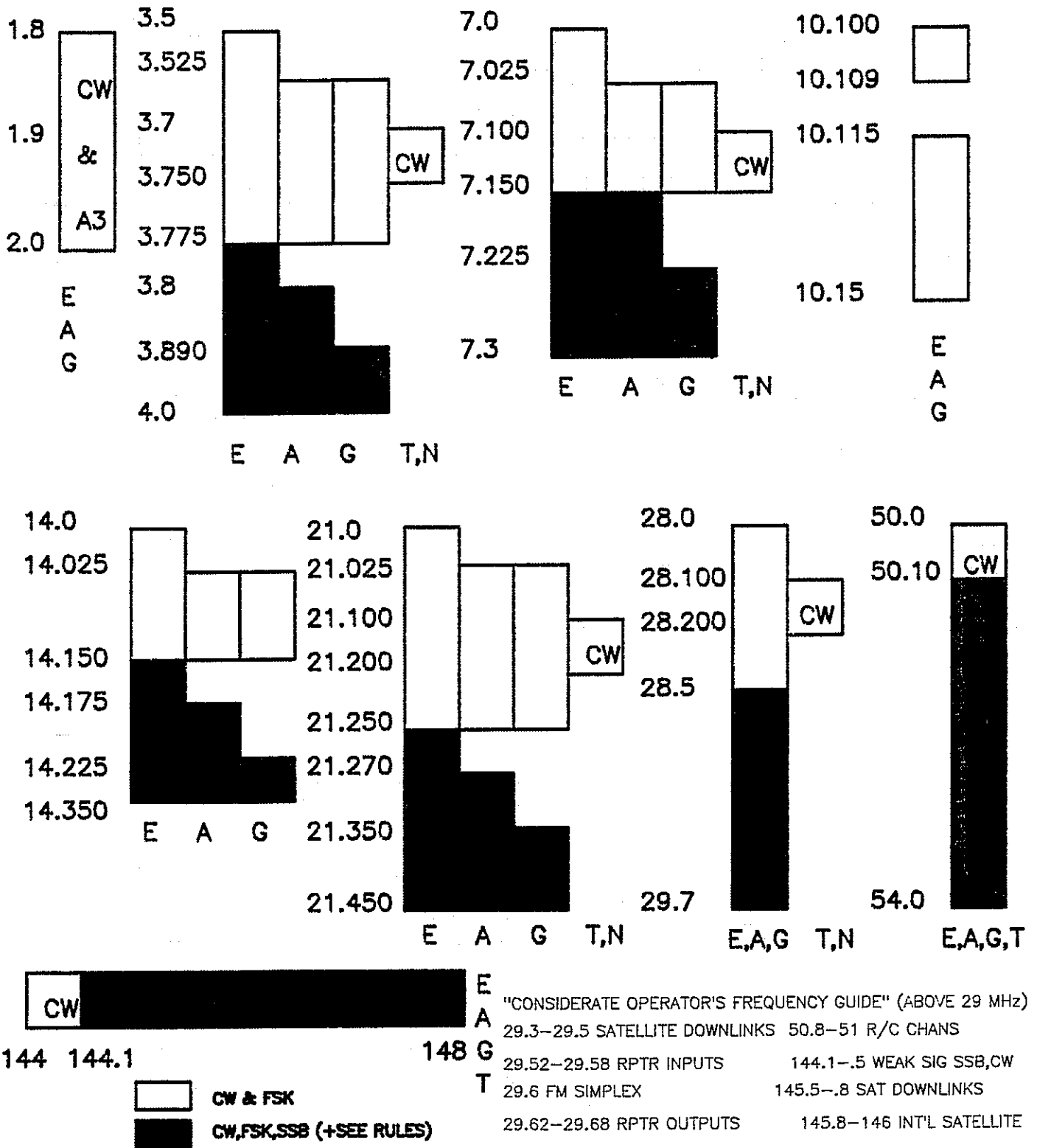

WAØJRB

SWAP....SALE....WANT...WHAT EVER.....

KEN..N6GX1, 584-8834...FOR SALE 10 METER BEAM, FYNCO, NEW IN BOX \$60.00..
 PHIL..KB6DIO..SALE OR SWAP..VARIBALE AIR CAPS, TRANSFORMERS, ROLLER INDUCTORS PHONE 542-2218
 PETE..KB6IL..575-3233..TOWER,42 FT. PLUS 8FT TUBE, TILT OVER AND FREE STANDING..TRI BANDER
 BEAM, 10-15-20 ..HAM 3 ROTOR, CONTROL WITH BRAKE, COAX AND CONTROL CABLE.....
 \$500.00 OR TRADE FOR MULTI BAND OR MODE TWO METER GEAR..
 WA6NJR..415-886-1608 FOR SALE HUNTER 20 MTR. HI PWR. RESONATOR \$15.00 ..OR SWAP FOR LOW PWR.
 N60J..763-2528...HOT WATER 16 FOR SALE..\$65.00...MISC. S LINE..KWM2 ...PHONE
 K6ANP ..LEN..795-4335... 2--500Z FOR SALE \$125.00 ..PHONE
 GEO..K7WVA...FOR SALE TR4C..PWR..WITH LIN. AMP.\$600.00,..PHONE 415-663-8041.
 BILL..WA7WTT..WANTS XTAL RIG ICOM UHF IC30..702-462-1519.
 GEO..KS6W...WANTS HI-GAIN-HI TOWER...80/10..PHONE...528-0201
 RON..WA6NBR...545-3813..FOR SALE R4B-RCV.-T4XB-TR, MS4-SPK-PWR-AND CABLES..~~\$400.00~~
 DICK..W6MHJ... FOR SALE..SB104A..PWR..SPK..MIKE..SHOP UPDATED AT FACTORY IN BOX..\$450.00

APRIL 4..HOME BREW CONTEST
 APRIL 7..APPLE BLOSSOM..SEBASTOPOL
 APRIL 8..APPLE JUICE RUN, SEBASTOPOL
 APRIL 29..MARCH OR DIMES
 MAY ??????
 JUNE 19.. ARMED FORCES DAY
 JUNE 23-24..FIELD DAY WHERE??
 JULY 4..KENWOOD RUN SEE JIM WA6PER
 JULY 28..CLUB PICNIC..DOYLE
 AUGUST....ARRL CONVENTION
 SEPT 15..FLEA MARKET, SEBASTOPOL COMM CENTER,
 QCWA PICNIC. CHEESE FACTORY
 OCTOBER ..NOM. FOR MEMBER OF YEAR AWARD..NOM.
 OF OFFICERS FOR 85
 NOVEMBER 7..ELECTION OF OFFICERS 85
 DECEMBER 8..XMAS PARTY, NO CLUB MEETING, NEW
 OFFICERS INSTALLED.

Radio Shack

STORE NO. 3855

ZANE BATES
MANAGER

510 FARMERS LANE TELEPHONE
 SANTA ROSA, CA. 95405 546-8423

SCHEDULE OF LOCAL NETS:

DAY	TIME	FREQUENCY	NET NAME
SUN	1000 PST	3.920 MHz	Northern California Emergency Net
	2000 PST	28.720 MHz	Bigfoot Chapter, 10- X International
MON	2000 PST	FWRA rpters	SKYWARN (Primary): ARES/RACES (County wide coordination - secondary)
WED	2000 PST	FWRA rpters	FAR WEST REPEATER ASSOCIATION:
	after FWRA	146.10/70	ARES/RASES (Central Humboldt)
THU	0700 PST	FWRA rpters	SKYWARN <i>RAIN</i>

KEN...WB6NOV...575-0916...R390 RCVR., KLIEN SCHMIDT RTTY...TRADE FOR TWO METER HT.....
 DAN...823-3199... SALE..TS520..MC50 MIKE...SWAN 3000 , COLLINS 30L1, TH6DX TRI BANDER
 DENTRON TRANSMATCH 160-10AT...CALL



AMSAT

AMSAT, THE RADIO AMATEUR SATELLITE CORPORATION SATELLITE BANDPLAN



AMSAT

L BAND BANDPLAN

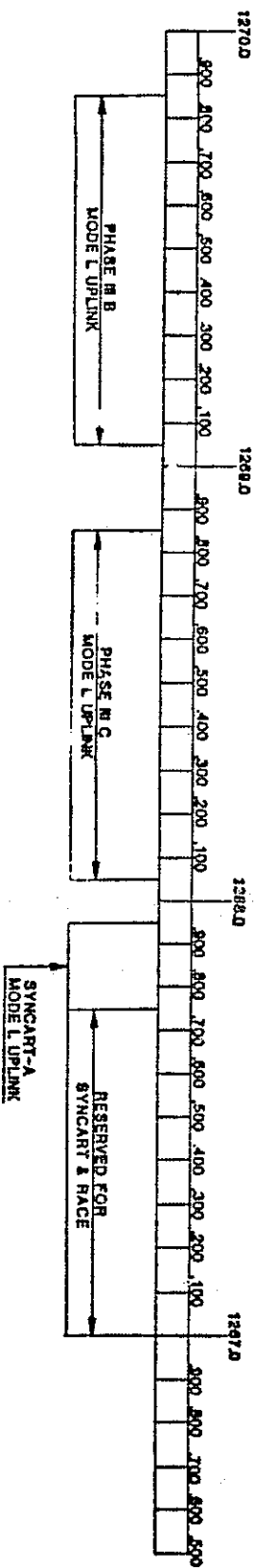

UHF BANDPLAN

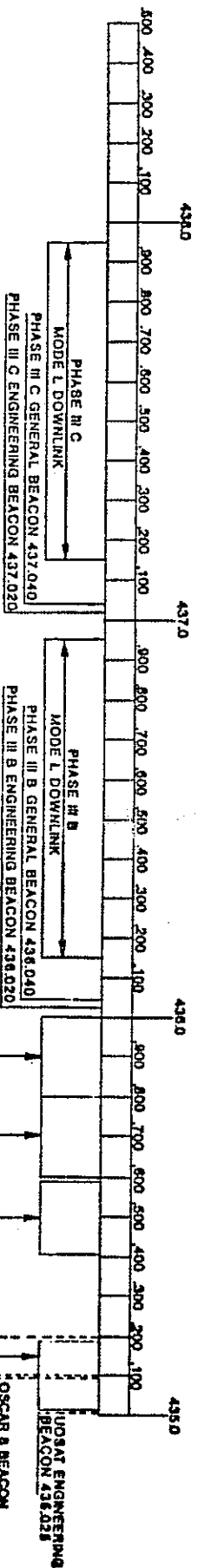

VHF BANDPLAN

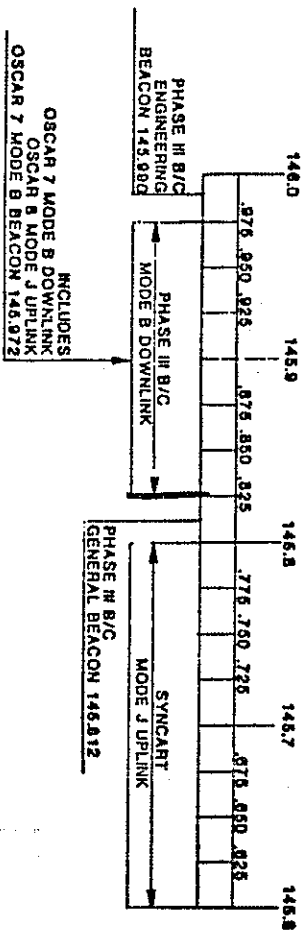

INCLUDES
OSCAR 7 MODE B DOWNLINK
OSCAR 8 MODE J UPLINK
OSCAR 7 MODE B BEACON 145.972

RESERVED FOR
SYNCART & RACE
EXPANSION

OSCAR 8 BEACON
435.025MHZ
PHASE III B
MODE B UPLINK
OSCAR 8 MODE
J DOWNLINK

WABLLY	72	45	3240
KD6NT	22	17	374
NIAL	8	7	56
KE6WL	3	3	9

GENERAL/ADVANCED/EXTRA

N6IIV	14	12	168
KB6DIO	12	8	96

NOVICE/TECHNICIAN

Call	QSOs	Sections	Score
------	------	----------	-------

The first annual SCRA Novice Roundup competition was successful. Five members submitted logs although several others were heard on. The winner in the Novice/Technician class was N6IIV, Brian. Steve, WABLLY had the highest score among the General/Advanced/Extra class operators. All 50 states were worked by our members. Results are as follows.

SCRA NOVICE ROUNDUP COMPETITION RESULTS

SONOMA COUNTY RADIO AMATEURS INC.

P. O. BOX 116

SANTA ROSA, CA. 95402

HANS BERG
 DJ6TJ
 MENGSTR 37
 2400 LUEBECK WEST GERM

FIRST CLASS

APRIL IS HOME BREW MONTH

